

Series NF

Air Chuck

Bore Size(mm) : NFH(L)2-Ø10, Ø16, Ø20, Ø25, Ø32, Ø40 / NFW2-Ø10, Ø12, Ø16, Ø20, Ø25, Ø30 / NFP2-Ø12, Ø16, Ø20, Ø25, Ø32, Ø40 / NFS-Ø10, Ø16, Ø20, Ø25

- COMFORTABLE ATTACHMENT
- COMPACT DESIGN
- GUARANTEE HIGH STRENGTH AND HIGH PRECISION
- SUPERB DURABILITY

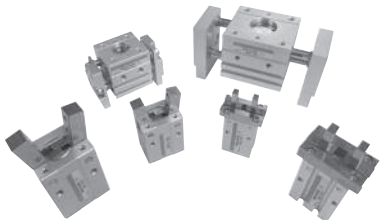

How to Order

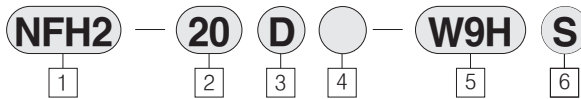

1] AIR CHUCK Series

New
Finger
Block
2 : Number of blocks

2] Bore Size - Opening/Closing Stroke(mm)

Title	Bore Size	Opening/Closing Stroke
10	10	4
16	16	6
20	20	10
25	25	14
32	32	40
40	40	30

3] Action

D : Double Acting type
S : Single Acting type (normally opened)
T : Single-acting (normally closed)

4] Finger option

D : Basic type (opening/closing direction)
1 : Side-tapped mounting
2 : Through-holes in opening/closing direction

5] Auto Switch

Blank : None (Built-in magnet)
W9H : Micro solid state switch (Horizontal type)
W9V : Micro solid state switch (Vertical type)
W20H : Solid state switch (2 color)

6] Number of switches

Blank: 2 pcs
S : 1 pc

NFH2 (Double Motion Type)

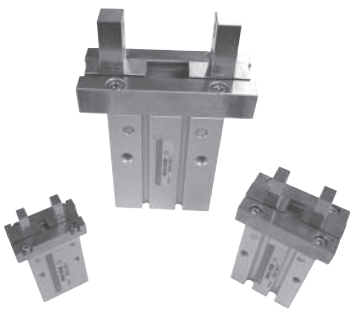

Symbol

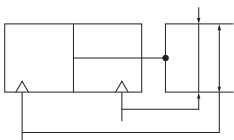

Specification Along Dimensions

Type	NFH2-06	NFH2-10	NFH2-16	NFH2-20	NFH2-25	NFH2-32	NFH2-40		
Action	D S T	D S T	D S T	D S T	D S T	D S T	D S T		
Bore size (mm)	6	10	16	20	25	32	40		
Opening / Closing Stroke (mm)	Closing width	8	6	7	7	9	28	30	
	Opening width	12	10	13	17	23	48	60	
	STROKE	4	4	6	10	14	22	30	
Theoretical gripping force (kgf) Air pressure applied 5kg/cm ²	Closed	0.3 0.2 - 1.4 0.9 - 3.9 2.9 - 4.6 3.3 - 6.9 5.5 - 16.7 13.2 - 28 21.6 -							
	Opened	0.6 - 0.4 2.1 - 1.8 5.4 - 4.8 7.3 - 6.2 12 - 10.8 20.8 - 18 35.2 - 31.1							
Port Size	M3	M3	M5	M5	M5	M5	M5		
Main body weight (kg)	0.027	0.058	0.138	0.25	0.476	0.836	0.88	1.446	1.552
Maximum gripping length (mm)	30		35	60	80	100	100		
Fluid	Air								
Operating pressure (kg/cm ²)	3 ~ 7								
Lubricant Applied	Unnecessary								
Ambient and fluid temperature(°C)	5 ~ 60								
Repeat opening/closing location distance (mm)	Initial value	±0.01	±0.01	±0.01	±0.01	±0.01	±0.02	±0.02	
	After 1 million times operation	±0.1	±0.1	±0.05	±0.05	±0.05	±0.05	±0.05	
Critical performance times (C.P.M)	160	160	160	160	160	60	60		
Auto switch for opening/closing checking	W9H, W9V, W20H								

Note 1) Theoretical gripping force is the value at stroke center.

Series NF

NFHL2



Symbol

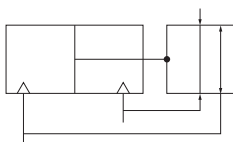

How to Order

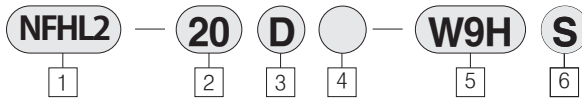

1 AIR CHUCK Series

New
Finger
Horizontal
Long stroke
2 : Number of fingers

2 Bore Size -Opening/Closing Stroke(mm)

Title	Bore Size	Opening/Closing Stroke
10	10	8
16	16	12
20	20	18
25	25	22

3 Action

D : Double Acting type
S : Single Acting type(contact)

4 Finger option

Blank: Basic type
(opening/closing direction)
1 : Side-tapped mounting
2 : Through-holes in opening/
closing direction

5 Auto Switch

Blank: None (Built-in magnet)
W9H: Micro solid state switch
(Horizontal type)
W9V: Micro solid state switch
(Vertical type)
W20H: Solid state switch (2 color)

6 Number of switches

Blank: 2 pcs
S : 1 pc

- SB
- NF**
- NR
- ASL
- LOW SPEED CYLINDER
- CHANGE OF ROD END SHAPE
- TPC-1000 TPC-1200
- SAH
- NBU
- ACU
- SE
- ARM

Specification Along Dimensions

Type		NFHL2-10D	NFHL2-16D	NFHL2-20D	NFHL2-25D
Bore Size (mm)		10	16	20	25
Opening/Closing Stroke (mm)	Closing Width	11	15	16	19
	Opening Width	19	27	34	41
	Stroke	8	12	18	22
Theoretical Gripping Force(kgf)	Closed	1.2	3.2	4.8	6.6
	Opened	1.9	5.2	7.4	11.2
Air Pressure Applied 5kgf/cm ²		1.9	5.2	7.4	11.2
Port Size		M3	M5	M5	M5
Main Body Weight(kgf)		0.06	0.15	0.31	0.56
Maximum Gripping Length L(mm)		30	35	60	80
Fluid		Air	Air	Air	Air
Operating Pressure		3 ~ 7	3 ~ 7	3 ~ 7	3 ~ 7
Lubricant Applied		Unnecessary	Unnecessary	Unnecessary	Unnecessary
Ambient and Fluid Temperature		5 ~ 60	5 ~ 60	5 ~ 60	5 ~ 60
Repeat Opening/Closing Initial Value		±0.01	±0.01	±0.01	±0.01
Location Distance(mm) After 1 million Times Operation		±0.1	±0.05	±0.05	±0.05
Critical Performance Times(C.P.M)		120	120	120	120
Auto Switch for Opening/Closing Checking		W9H,W9V, W20H	W9H,W9V, W20H	W9H,W9V, W20H	W9H,W9V, W20H

Note 1) Theoretical gripping force is the value at stroke center.

Series NF

NFW2

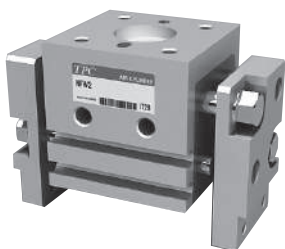

Symbol

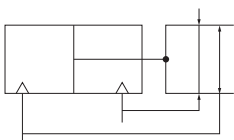

How to Order

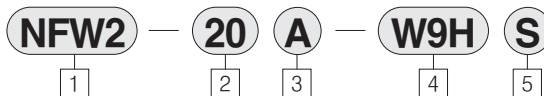

1] AIR CHUCK Series

New
Finger
Horizontal
2 : Number of fingers

2] Bore Size-Opening/Closing Stroke(mm)

Title	Bore Size	Opening/Closing Stroke
10	10	10
12	12	20
16	16	30
20	20	40
25	25	50
30	30	60

3] Operating Method

A : Vertical Direction
B : Horizontal Direction

4] Auto Switch

Blank : None
W9H : Mini solid state auto switch
(Horizontal type)
W9V : Mini solid state auto switch
(Vertical type)

5] Number of Auto Switches

Blank : 2 pcs
S : 1 pc

Specification Along Dimensions

Type	NFW2-10	NFW2-12	NFW2-16	NFW2-20	NFW2-25	NFW2-30
Bore Size (mm)	10	12	16	20	25	30
Opening/Closing Stroke (mm)	Closing Width	36	44	54	76	90
	Opening Width	46	64	84	116	140
	Stroke	10	20	30	40	50
Theoretical Gripping Force(kgf) Air Pressure Applied 5kgf/cm ²	Closed	2.5	3.7	7.5	11.8	18.9
	Opened					
Port Size	M5	M5	M5	M5	M5	M5
Main Body Weight(kgf)	0.18	0.30	0.45	1.0	1.75	2.7
Maximum Gripping Length L(mm)	30	45	75	100	120	150
Fluid	Air	Air	Air	Air	Air	Air
Operating Pressure	3 ~ 7	3 ~ 7	3 ~ 7	3 ~ 7	3 ~ 7	3 ~ 7
Lubricant Applied	Unnecessary	Unnecessary	Unnecessary	Unnecessary	Unnecessary	Unnecessary
Ambient and Fluid Temperature	5 ~ 60	5 ~ 60	5 ~ 60	5 ~ 60	5 ~ 60	5 ~ 60
Repeat Opening/Closing Initial Value	±0.1	±0.1	±0.1	±0.1	±0.1	±0.1
Location Distance(mm) After 1 million Times Operation	±0.2	±0.2	±0.2	±0.2	±0.2	±0.2
Critical Performance Times(C.P.M)	60	60	60	60	60	60
Auto Switch for Opening/Closing Checking	W9H,W9V,W20H	W9H,W9V,W20H	W9H,W9V,W20H	W9H,W9V,W20H	W9H,W9V,W20H	W9H,W9V,W20H

Note 1) Theoretical gripping force is the value at stroke center.

Series NF

NFP2



Symbol

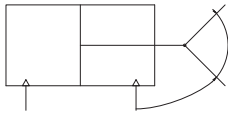

How to Order

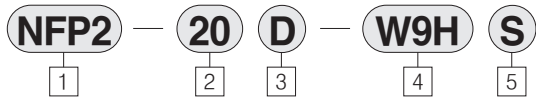

1] AIR CHUCK Series
 New
 Finger
 Horizontal
 2 : Number of fingers

2] Bore Size-Opening/Closing Stroke(mm)

Name	Bore Size	Opening/Closing Stroke
12	12	-5° ~ 15°
16	16	
20	20	
25	25	-5° ~ 20°
32	30	
40	40	

3] Action
 D : Double Acting type

4] Auto Switch
 Blank : None (built-in Magnet)
 W9H : Mini solid state auto switch (Horizontal type)
 W9V : Mini solid state auto switch (Vertical type)
 Auto Switch attaching unavailable (NFP-12, NFP2-16)

5] Number of Auto Switches
 Blank : 2 pcs
 S : 1 pc

- SB
- NF**
- NR
- ASL
- LOW SPEED CYLINDER
- CHANGE OF ROD END SHAPE
- TPC-1000
TPC-1200
- SAH
- NBU
- ACU
- SE
- ARM

Specification

Type	NFP2-12D	NFP2-16D	NFP2-20D	NFP2-25D	NFP2-32D	NFP2-40D	
Bore Size (mm)	12	16	20	25	32	40	
Opening/Closing Range (°)	-5 ~ 15	-5 ~ 15	-5 ~ 20	-5 ~ 20	-5 ~ 20	-5 ~ 20	
Theoretical Gripping Force(kgf)	Closed	1.1	1.7	2.4	4.2	7.1	11.8
Air Pressure Applied 5kgf/cm ²	Opened	1.4	2.2	3.2	5.5	8.5	14.1
Port Size	M5	M5	M5	M5	PT1/8	PT1/8	
Main Body Weight(kgf)	0.05	0.09	0.2	0.25	0.4	0.75	
Soft Jaw Allowance Length L(mm)	45	60	70	75	85	120	
Fluid	Air	Air	Air	Air	Air	Air	
Operating Pressure	3 ~ 7	3 ~ 7	3 ~ 7	3 ~ 7	3 ~ 7	3 ~ 7	
Lubricant Applied	Unnecessary	Unnecessary	Unnecessary	Unnecessary	Unnecessary	Unnecessary	
Ambient and Fluid Temperature	5 ~ 60	5 ~ 60	5 ~ 60	5 ~ 60	5 ~ 60	5 ~ 60	
Repeat Opening/Closing	Initial Value	±0.1	±0.1	±0.1	±0.1	±0.1	
Location Distance(mm)	After 1 million Times Operation	±0.2	±0.2	±0.2	±0.2	±0.2	
Critical Performance Times(C.P.M)		60	60	60	60	60	
Auto Switch for Opening/Closing Checking	-	-	W9H,W9V,W20H	W9H,W9V,W20H	W9H,W9V,W20H	W9H,W9V,W20H	

Note 1) Theoretical gripping force is the value at stroke center.

Series NF



- IMPROVED DESIGN FOR PREVENTING FROM A BREAKAWAY OF HINGE PIN EASY MAINTENANCE
- STAINLESS STEEL
- RESISTANCE IMPROVED BY USING ENGINEERING PLASTIC FLANGE BUSH
- DUST PROOF CONSTRUCTION

How to Order

Symbol

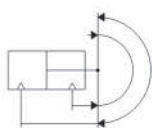

NFS 2 - 10 D - W9H S

1 2 3 4 5

1 Number of Fingers

2 : 2 Fingers

2 Bore Size

10 : ϕ 10
16 : ϕ 16
20 : ϕ 20
25 : ϕ 25

3 Action

D : Double Acting

4 Auto Switch

Blank : None

W9H : Mini Solid State Auto Switch(Horizontal)

W9V : Mini Solid State Auto Switch(Vertical)

W10H : Mini Solid State Auto Switch(Vertical)

5 Number of Auto Switches

Blank : 2 pcs

S : 1 pc

Specifications

Model	NFS2-10D	NFS2-16D	NFS2-20D	NFS2-25D
Bore Size(mm)	10	16	20	25
Opening Range(°)	-3 ~ 180			
Port Size	M5			
Weight(Kgf)	0.08	0.16	0.32	0.56
Fluid	Air			
Operating Pressure(Mpa)	0.2 ~ 0.6			
Lubrication	Not Required			
Temperature(°C)	5 ~ 60°C			
Auto Switch	W9H, W9V, W10V, W20H (Solid State)			

Performance

Model	*Gripping Moment Nm	Over Length (mm)	Repeatability	Max. Operating Frequency (C.P.M)
NFS2-10D	0.14	45	±0.2	60
NFS2-16D	0.54	60		
NFS2-20D	1.12	74		
NFS2-25D	2.03	90		

*Gripping moment is based on pressure 0.5MPa.

Series NF

Construction

NFH(L)2

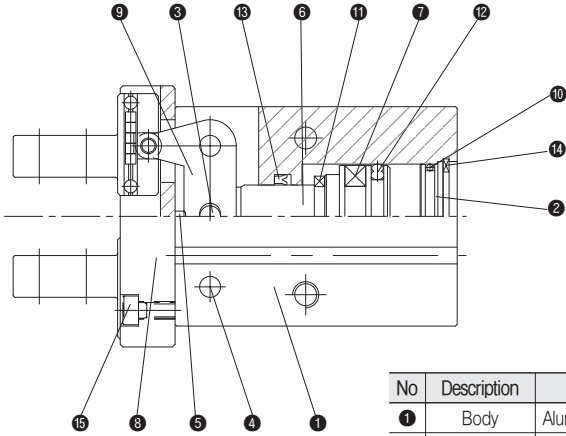

No	Description	Material	Note	No	Description	Material	Note
1	Body	Aluminum Alloy		9	Link	Carbon Steel	Nickel Plated
2	Head Cover	Aluminum Alloy		10	Tube Gasket	NBR	
3	Hinge Pin	Carbon Steel	Heat Treated	11	Bumper	Urethane Rubber	
4	Link Pin	Carbon Steel	Heat Treated	12	Piston Packing	NBR	
5	Dowel Pin	Carbon Steel	Heat Treated	13	Rod Packing	NBR	
6	Piston Rod	Aluminum Alloy		14	Snap Ring	Carbon Steel	
7	Magnet	Magnet		15	Socket Bolt	Carbon Steel	Nickel Plated
8	Finger Ass'y	Carbon Steel	Nickel Plated				

NFW2

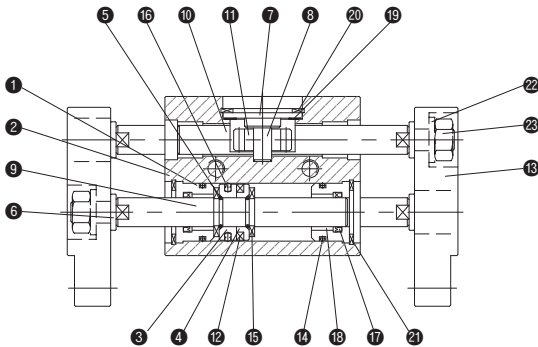

No	Description	Material	Note	No	Description	Material	Note
1	Rod Cover	Aluminum Alloy		13	Finger	Aluminum Alloy	Nickel Plated
2	Body	Aluminum Alloy		14	Tube Gasket	NBR	
3	Piston	Aluminum Alloy		15	Bumper	Urethane Rubber	
4	Magnet Seat	Aluminum Alloy		16	Piston Packing	NBR	
5	Wire Ring	Spring Wire		17	Rod Packing	NBR	
6	Washer		Nickel Plated	18	Du Bush		
7	Cover		Nickel Plated	19	Washer	Carbon Steel	
8	Pinion Shaft	Carbon Steel	Chrome Plated	20	Snap Ring	Carbon Steel	
9	Piston Rod	Stainless		21	Snap Ring	Carbon Steel	
10	Rack Gear	Stainless		22	Plain Washer	Carbon Steel	
11	Pinion	Carbon Steel	Nitriding	23	Lock Nut	Carbon Steel	
12	Magnet	Magnet					

- SB
- NF**
- NR
- ASL
- LOW SPEED CYLINDER
- CHANGE OF ROD END SHAPE
- TPC-1000
TPC-1200
- SAH
- NBU
- ACU
- SE
- ARM

Series NF

Construction

NFP2

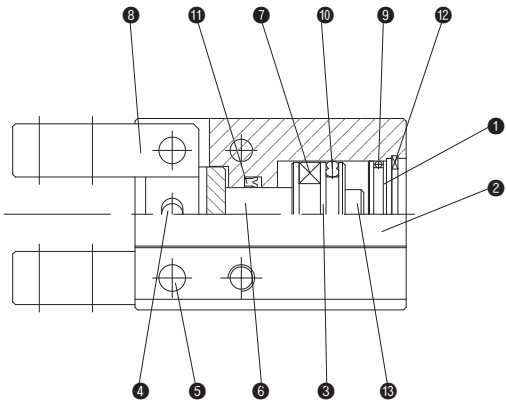

No	Description	Material	Note	No	Description	Material	Note
1	Head Cover	Aluminum Alloy		8	Finger	Carbon Steel	Nickel Plated
2	Body	Aluminum Alloy		9	Tube Gasket	NBR	
3	Piston	Aluminum Alloy		10	Piston Packing	NBR	
4	Hinge Pin	Carbon Steel	Heat Treated	11	Rod Packing	NBR	
5	Link Pin	Carbon Steel	Heat Treated	12	Snap Ring	Carbon Steel	
6	Piston Rod	Aluminum Alloy		13	Lock Nut	Carbon Steel	
7	Magnet	Magnet					

NFS2

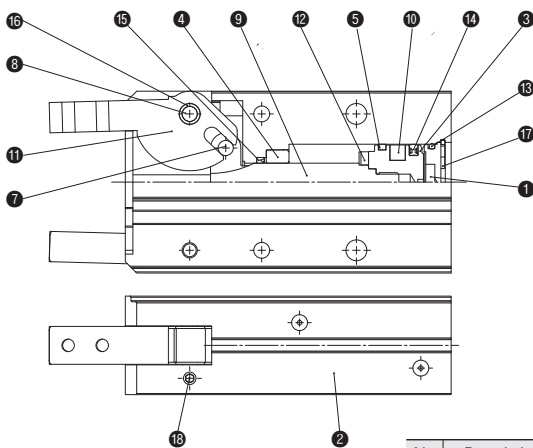

No	Description	Material	Note	No	Description	Material	Note
1	Head Cover	Aluminum Alloy		11	Finger	Stainless Steel	
2	Body	Aluminum Alloy		12	Bumper	Urethane	
3	Piston	Aluminum Alloy		13	Tube Gasket	NBR	
4	Bush	Copper		14	Piston Packing	NBR	
5	Wear Ring	Resin		15	Rod Packing	NBR	
6	Cover Plate	Stainless Steel		16	Bush	Resin	
7	Hinge Pin	Carbon Steel		17	Snap Ring	Carbon Steel	
8	Link Pin	Carbon Steel		18	Set Screw	Carbon Steel	
9	Piston Rod	Stainless Steel		19	F-Head Cap HEX. Socket Bolt	Carbon Steel	
10	Magnet	Magnet					

Series NF

Air Chuck Horizontal Opening/Closing Type

NFH2 Ø10, Ø16, Ø20, Ø25, Ø32, Ø40

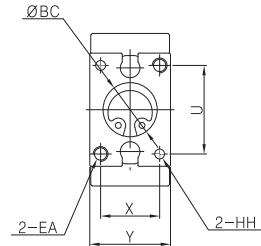
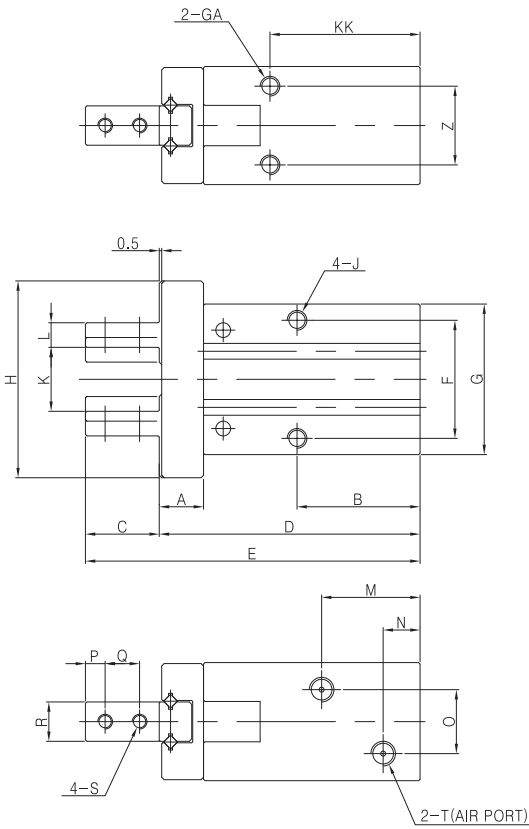

★ (In case of Ø10)
 ※ Unable to attach penetration hole through "J", when switch attached(Ø10)

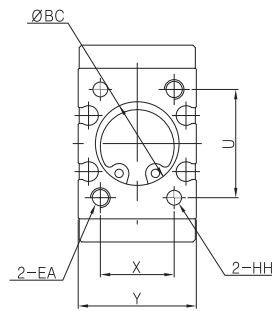

★ (In case of Ø16~Ø20)

- SB
- NF**
- NR
- ASL
- LOW SPEED CYLINDER
- CHANGE OF ROD END SHAPE
- TPC-1000
TPC-1200
- SAH
- NBU
- ACU
- SE
- ARM

Bore Size (mm)	Range of Opening/Closing (mm)	A	B	C	D	E	F	G	H	J	K	L	M	N	O	P	Q	R	S
10	4	7	23	12	45	57	16	23	31	M3 DP5	OPEN = 10 CLOSE = 6	4	19	7	10	3	5.5	5 ⁰ _{-0.05}	M2.5 Through
16	6	9	25	15	53	68	24	30.6	40	M4 DP8	OPEN = 13 CLOSE = 7	5	19	7.5	13	4	7	8 ⁰ _{-0.05}	M3 Through
20	10	11	29	20	65	85	30	42	50	M5 DP10	OPEN = 17 CLOSE = 7	8	22.5	8	15	5	9	10 ⁰ _{-0.05}	M4 Through
25	14	14	30	25	78	103	36	52	64	M6 DP12	OPEN = 23 CLOSE = 9	10	23.5	8	20	6	12	12 ⁰ _{-0.05}	M5 Through

Bore Size (mm)	Range of Opening/Closing (mm)	T	U	X	Y	Z	ØBC	EA	KK	GA	HH
10	4	M3	18	12	16.4	11	11 DP1.3	M3 DP6	27	M3 DP6	Ø2 H9 DP3
16	6	M5	22	15	24	16	17 DP1.3	M4 DP8	30.5	M4 DP5.5	Ø3 H9 DP3
20	10	M5	32	18	28	19	21 DP1.5	M5 DP10	35	M5 DP8	Ø4 H9 DP4
25	14	M5	40	22	34	22	26 DP1.5	M6 DP12	36.5	M6 DP10	

Series NF

Air Chuck Horizontal Opening/Closing Type

NFHL Ø10, Ø16, Ø20, Ø25, Ø32, Ø40

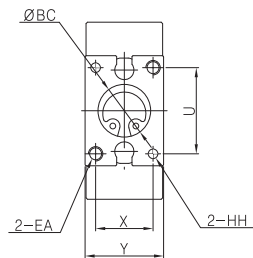
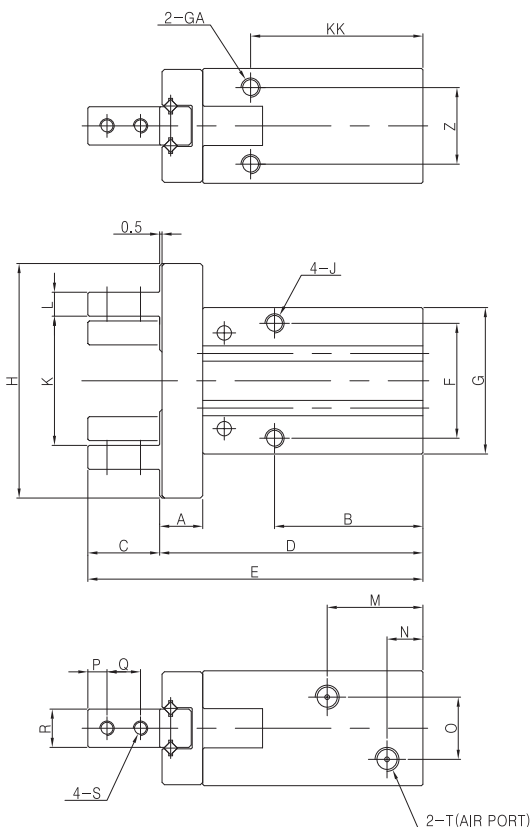

★ (In case of Ø10)
 ※ Unable to attach penetration hole through "J",
 when switch attached (Ø10)

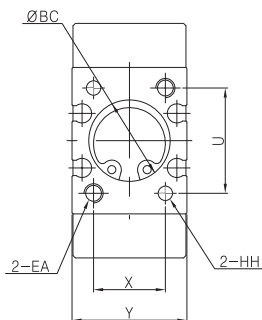

★ (In case of Ø16-Ø20)

Bore Size (mm)	Range of Opening/Closing (mm)	A	B	C	D	E	F	G	H	J	K	L	M	N	O	P	Q	R	S
10	8	7	25	12	45	57	16	23	37	M3 DP5	OPEN = 19 CLOSE = 11	4	19	7	10	3	5.5	5 ⁰ _{-0.05}	M2.5 Through
16	12	9	31	15	55	70	24	30.6	49	M4 DP8	OPEN = 27 CLOSE = 15	5	19	7.5	13	4	7	8 ⁰ _{-0.05}	M3 Through
20	18	11	36	20	70	90	30	42	65	M5 DP10	OPEN = 34 CLOSE = 16	8	26	8	15	5	9	10 ⁰ _{-0.05}	M4 Through
25	22	14	40	25	81	106	36	52	77	M6 DP12	OPEN = 41 CLOSE = 19	10	29.5	8	20	6	12	12 ⁰ _{-0.05}	M5 Through

Bore Size (mm)	Range of Opening/Closing (mm)	T	U	X	Y	Z	ØBC	EA	KK	GA	HH
10	8	M3	18	12	16.4	11.4	11 DP1.3	M3 DP6	29	M3 DP6	Ø2 H9 DP3
16	12	M5	22	15	24	16	17 DP1.3	M4 DP8	36	M4 DP5.5	Ø3 H9 DP3
20	18	M5	32	18	28	18.6	21 DP1.5	M5 DP10	43	M5 DP8	Ø4 H9 DP4
25	22	M5	40	22	34	22	26 DP1.5	M6 DP12	48	M6 DP10	

Series NF

Air Chuck Double Width

NFW2 Ø10, Ø12, Ø16, Ø20, Ø25, Ø30

- SB
- NF
- NR
- ASL
- LOW SPEED CYLINDER
- CHANGE OF ROD END SHAPE
- TPC-1000
TPC-1200
- SAH
- NBU
- ACU
- SE
- ARM

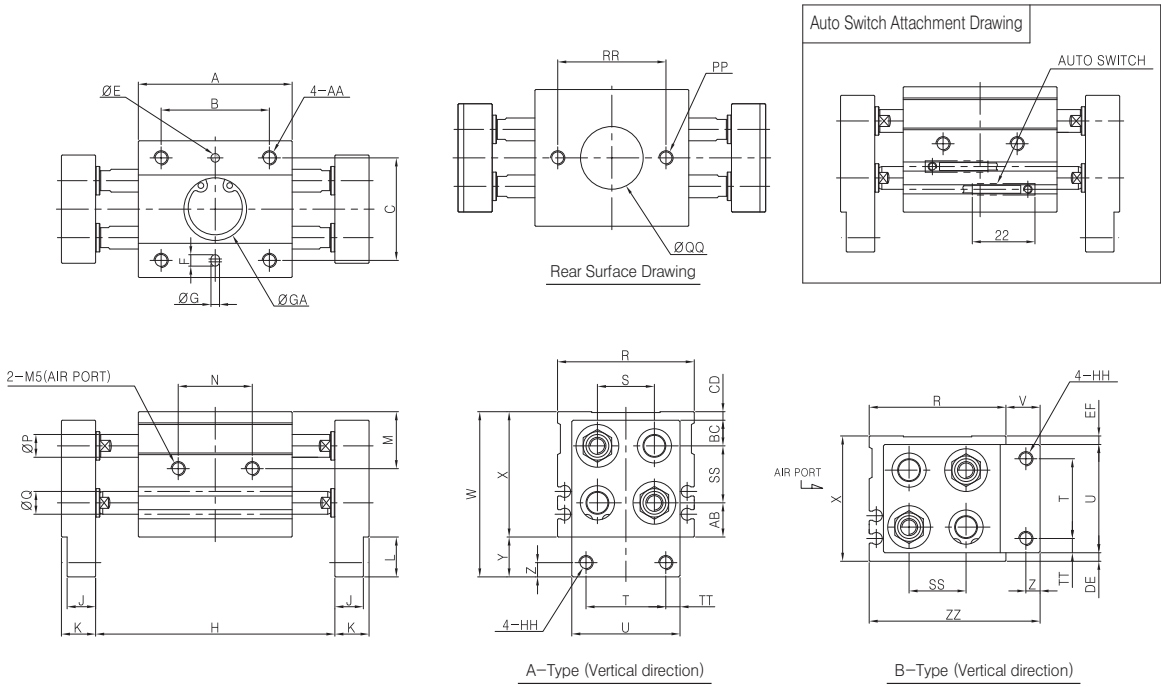

Bore Size (mm)	Range of Opening/Closing (mm)	A	AA	B	C	ØE	F	ØG	ØGA	H	J	K	L	M	N	ØP	ØQ
10	10	36	M4 DP5	22	22	3H9 ^{+0.025} ₀ DP3	4	3H9 ^{+0.025} ₀ DP3	15 ^{+0.05} ₀ DP3	OPEN = 46 CLOSE = 36	6	8	10	16.5	16	6	6
12	20	44	M4 DP6	30	30	3H9 ^{+0.025} ₀ DP3	4	3H9 ^{+0.025} ₀ DP3	15 ^{+0.05} ₀ DP3	OPEN = 64 CLOSE = 44	8	10	10	19	19	8	7
16	30	54	M5 DP6	38	36	3H9 ^{+0.025} ₀ DP3	4	3H9 ^{+0.025} ₀ DP3	22 ^{+0.05} ₀ DP3	OPEN = 84 CLOSE = 54	10	12	14	20	26	8	8
20	40	76	M6 DP7	56	30	4H9 ^{+0.030} ₀ DP4	5	4H9 ^{+0.030} ₀ DP4	22 ^{+0.05} ₀ DP5	OPEN = 116 CLOSE = 76	10	15	16	31	36	12	10
25	50	90	M6 DP7	58	44	4H9 ^{+0.030} ₀ DP4	5	4H9 ^{+0.030} ₀ DP4	22 ^{+0.05} ₀ DP5	OPEN = 140 CLOSE = 90	12	20	18	34	43	14	12
30	60	110	M8 DP8	72	44	4H9 ^{+0.030} ₀ DP5	5	4H9 ^{+0.030} ₀ DP5	30 ^{+0.05} ₀ DP5	OPEN = 170 CLOSE = 110	15	24	24	36	48	16	16

Bore Size (mm)	Range of Opening/Closing (mm)	R	S	T	U	V	W	X	Y	Z	AB	BC	CD	DE	EF	HH	PP	ØQQ	RR	SS	TT	ZZ
10	10	34	15	15	26	9.5	46	36	10	4	9	5.5	6.5	6.5	M3 Through	M4 DP5	15 ^{+0.05} ₀ DP2.5	26	15	5.5	43.5	
12	20	42	18	18	32	8	50	40	10	4	10	7.5	4.5	3	5	M4 Through	M4 DP6	15 ^{+0.05} ₀ DP2.5	32	18	7	50
16	30	48	20	28	38	12	58	44	14	5	12	9	3	3	3	M5 Through	M5 DP6	22 ^{+0.05} ₀ DP2.5	38	20	5	60
20	40	58	26	30	48	14	76	60	16	8	14	11	9	3	9	M6 Through	M6 DP7	22 ^{+0.05} ₀ DP2.5	56	26	9	72
25	50	68	30	38	58	18	88	70	18	8	19	14	7	5	7	M6 Through	M8 DP8	22 ^{+0.05} ₀ DP3	58	30	10	86
30	60	74	34	40	62	24.5	100	77	23	12	21.5	15.5	6	7.5	7.5	M8 Through	M8 DP8	30 ^{+0.05} ₀ DP3	72	34	11	98.5

Series NF

Air Chuck Point Opening/Closing

NFP2 Ø12, Ø16, Ø20, Ø25, Ø32, Ø40

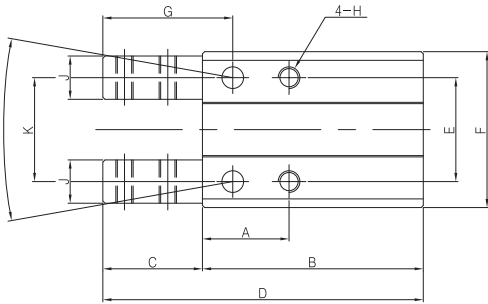

※ A "H" tap drill is from Ø12~Ø25 which are available for penetration attachment.

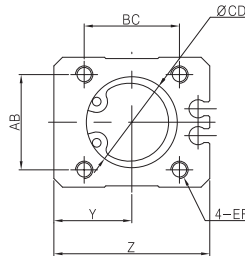
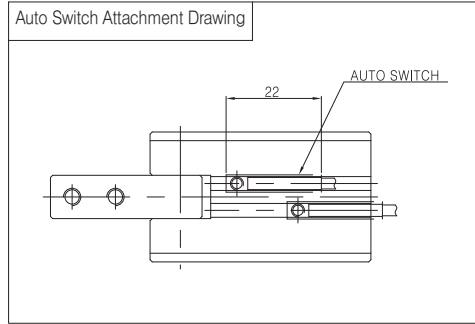
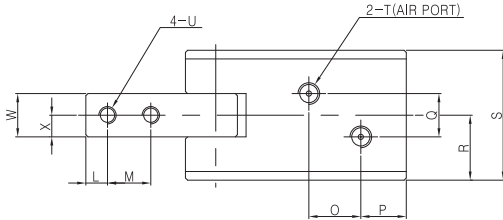

★(In case of Ø50~Ø40)

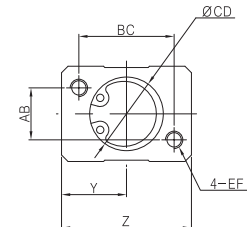

★(In case of Ø12~Ø16)
※ Auto switch attachment unavailable

Bore Size (mm)	Range of Opening/Closing (mm)	A	B	C	D	E	F	G	H	J	K	L	M	O	P	Q	R	S	T	U	W ⁰ _{-0.1}
12	-5°~15°	14	35	13	48	18	26	18	M4 DP5	6	18	3	7	7.5	8	6	9	18	M5	M3 Through	7
16		16	39	17	56	20	30	23	M4 DP6	8	20	4	9	9	8	8	11	22	M5	M4 Through	8
20	-5°~20°	20	51	23	74	24	36	30	M5 DP6	10	24	5	10	12	10.5	10	15	30	M5	M4 Through	10
25		21	52	25	77	26	40	32	M5 DP8	10	28	5	12	11.5	10	13	18	36	M5	M5 Through	12
30		24	62	26	88	32	46	34	M5 DP10	12	32	5	12	15.5	13	12	20	40	R/C 1/8	M5 Through	14
40		27	72	32	104	40	56	41	M6 DP12	16	36	6	20	15.5	14	20	25	50	R/C 1/8	M6 Through	18

Bore Size (mm)	Range of Opening/Closing (mm)	X	Y	Z	AB	BC	CD	EF
12	-5°~15°	3.5	13	26	8	18	13 DP1.3	M3 DP6
16		4	15	30	12	22	17 DP1.3	M4 DP8
20	-5°~20°	5	18	36	22	22	21 DP1.5	M4 DP10
25		6	20	40	26	26	26 DP1.5	M5 DP12
30		7	23	46	28	28	32 DP1.5	M5 DP12
40		9	28	56	40	40	42 DP2	M6 DP15

Series NF

Dimensions

NFS2-10D

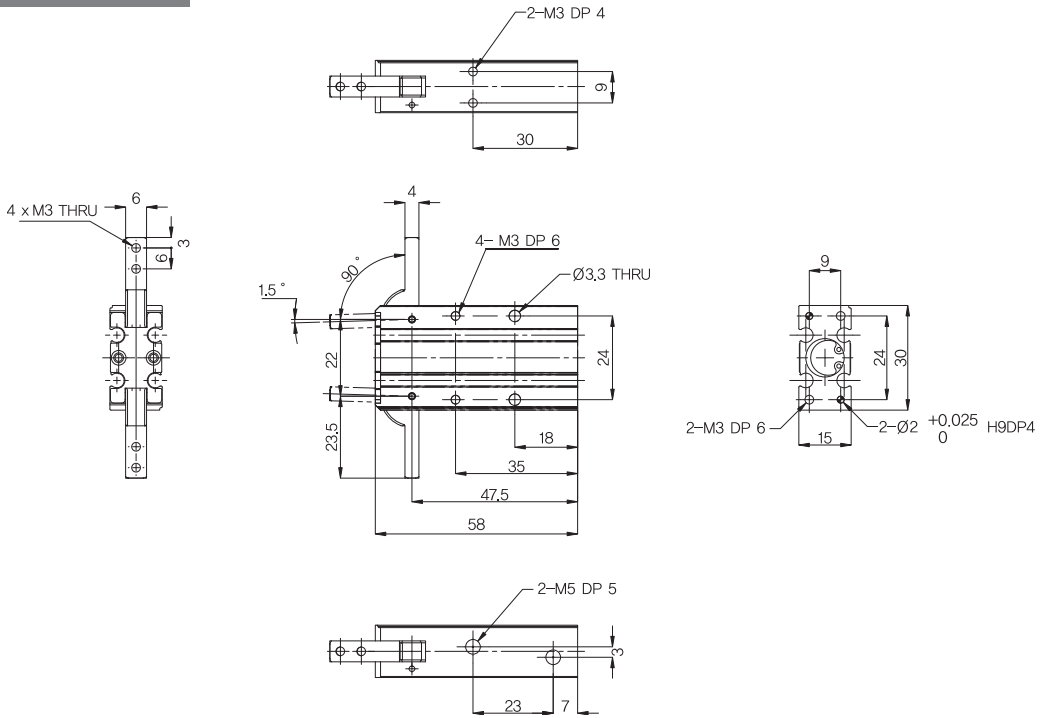

NFS2-16D

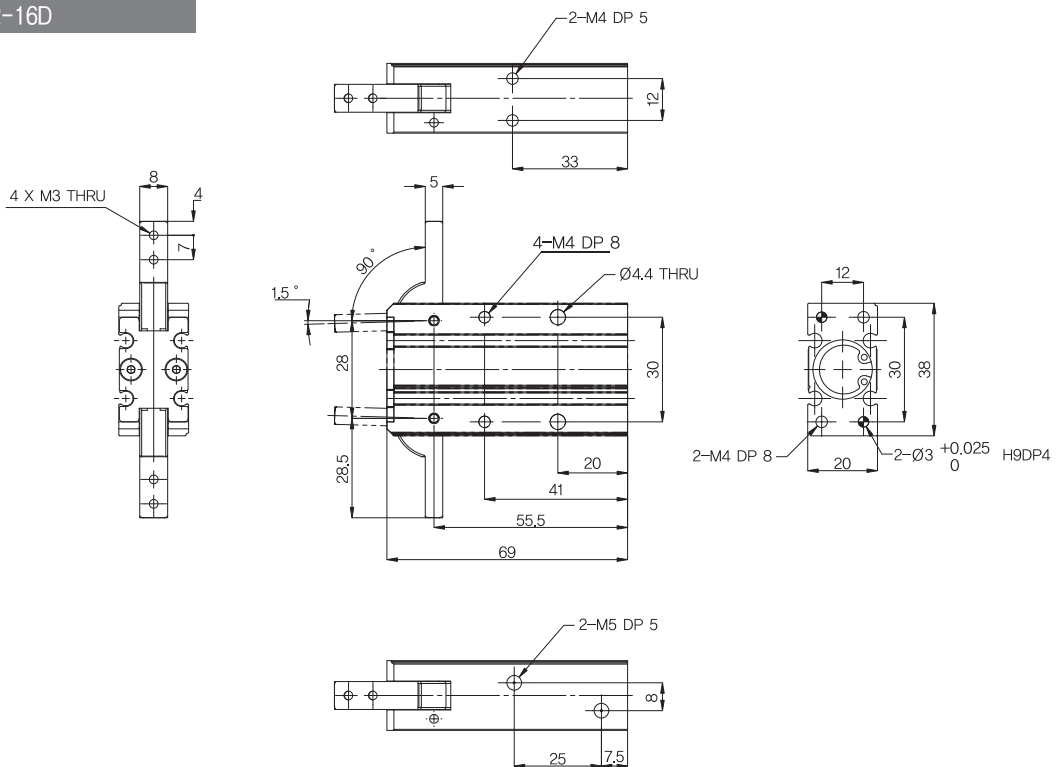

- SB
- NF**
- NR
- ASL
- LOW SPEED CYLINDER
- CHANGE OF ROD END SHAPE
- TPC-1000
- TPC-1200
- SAH
- NBU
- ACU
- SE
- ARM

Series NF

Dimensions

NFS2-20D

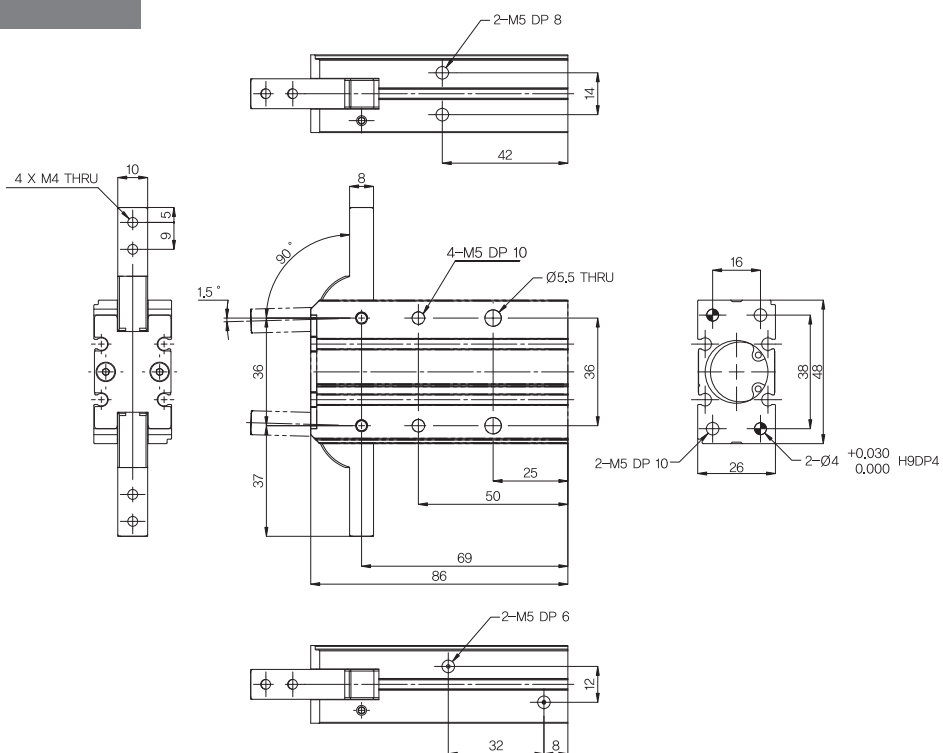

NFS2-25D

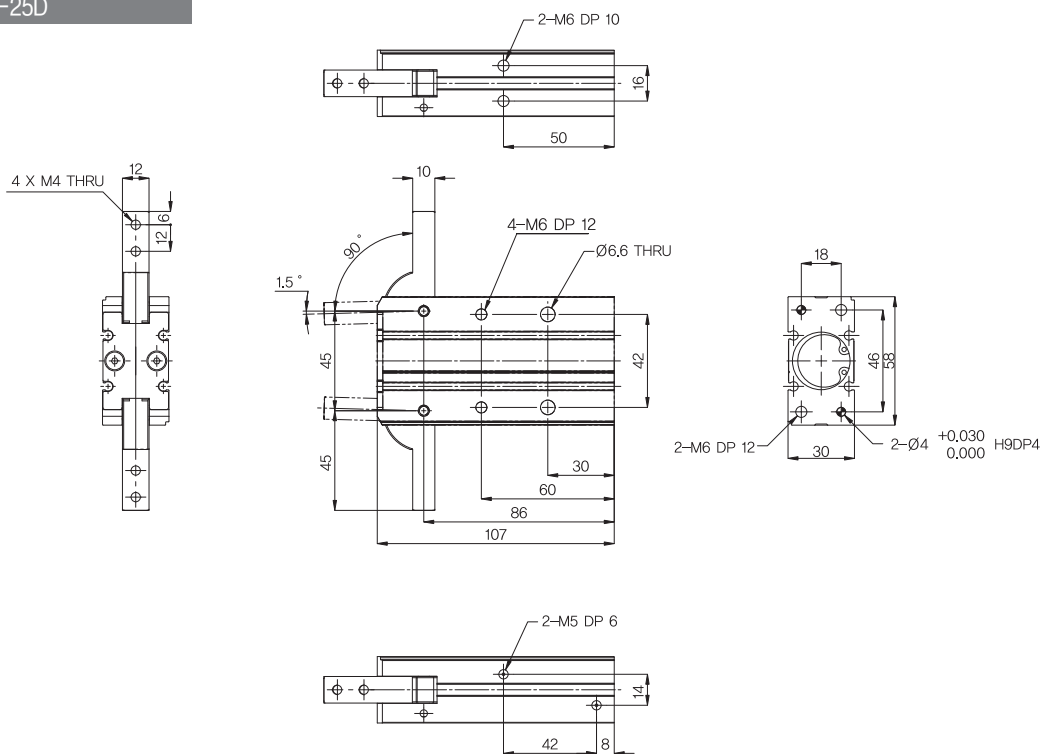

Series NF

Notices on Design

⚠ Warning

- ① Suitable safety measure should be set for possibility of danger to human body from moving work or possibility of putting fingers into finger cylinder.
- ② If circuit pressure is lowered owing to air source problem or power failure, work is possibly decreased because of gripping capability reduction. Measures for preventing damage of human body or machinery such as prevention of drop should be reserved.

Notices for Selection

⚠ Warning

- ① Install attachment short and light.
 - A. Heavy or long appendage cause shaking of finger part or negative influence to life lifespan owing to enlarged inertia.

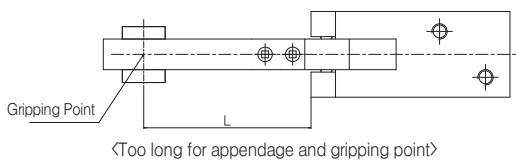

- B. It is recommended to have shorter and lighter gripping point within limit range.

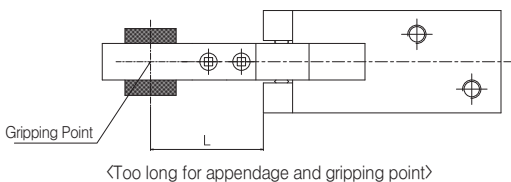

- C. In case of large scale work or long work, upgrade the size or use multiple numbers.

- ② Select a machine type with marginal gripping force for work weight. If selecting impractical machine type, it may cause drop of work. Refer to machine type selection standard for theoretical gripping force and work weight of each series.
- ③ Do not apply an operation causing excessive external force or impact, which causes failure of machine. If needed, contact a manufacturer.
- ④ Select a machine marginal for opening/closing width for work.

<In case of no margin>

- A. Deviation of air chuck opening/closing and work diameter may cause unstability of gripping.
- B. Application of auto switch may cause detection failure. Refer to auto switch differential of each series to guarantee marginal stroke for difference.

Notices for Attachment

⚠ Warning

- ① Do not bring damage or impact by dropping air chuck when attaching. Slight deformation may cause fire or operation failure.
- ② Please suitably conduct connection of screw when attaching air chuck or appendage within limited torque value. Connection out of limited range may cause operation failure, and lack of connection may cause inappropriate location or drop.

⚠ Notices

- ① In case of attaching appendage to finger, be cautious not to make finger twisted. It may cause shaking or fire.
- ② Adjust and check not to apply external force to finger. If repeated bending stress or excessive stress is applied to finger, it may cause shaking or damage to finger. Install clearance by moving stroke end of air chuck not to allow touch of work or appendage.

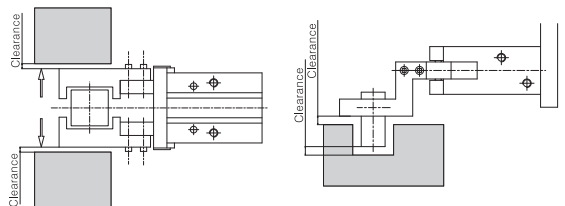

- ③ Be cautious not to allow excessive force for insertion of work with adjusting the center. Especially, check the safety not to make manual operation during test running, nor allow impact caused by low speed operation with lowering the pressure of cylinder.
- ④ Adjust controller not to allow excessive speed of finger opening/closing. In case of excessive speed of finger opening/closing which causes enlargement of impact, it may cause negative influence to work gripping repetition or lifespan.

SB
NF
NR
ASL
LOW SPEED CYLINDER
CHANGE OF ROD END SHAPE
TPC-1000 TPC-1200
SAH
NBU
ACU
SE
ARM

Series NF

Machine Type Selection Method

1 Condition Checking

- ① Weight (kg) of operating components
- ② Gripping method (external/internal diameter gripping)
- ③ Frictional coefficient (μ)
- ④ Marginal ratio (a)
- ⑤ Although frictional coefficient between appendage and work is different along the shape, please select machine type which allows more than 10~20 times bigger gripping force than work weight.
- ⑥ Moreover, there should be a margin considered for high degree of acceleration or impact when returning the work.

2 Calculation of Necessary Gripping Force

- ① Weight of operating component = 0.1(kg)
- ② Gripping method = Outer boundary grip
- ③ Frictional coefficient (μ)
- ④ Marginal ratio (a) = 4
- ⑤ Necessary gripping force (F)
 $F = mg / (2\mu) * a$
 - g : Gravitational acceleration(9.8 m/s²)
- ⑥ Calculation 1
 Gripping force is set to 10 times of work weight ($\mu = 0.2$)
 $F = 0.1\text{kg} * 9.8 \text{ m/s}^2 * 10 = 9.8(\text{N})$
- ⑦ Calculation 2
 Gripping force is set to 20 times of work weight ($\mu = 0.1$)
 $F = 0.1\text{kg} * 9.8 \text{ m/s}^2 * 20 = 19.6(\text{N})$

3 Machine Selection on gripping force graph

- ① Distance : L = 2cm
- ② Pressure : 0.3MPa
- ③ Conversion of gravity unit
 $1\text{MPa} \approx 10.2\text{kgf/cm}^2$
 $1\text{N} \approx 0.102\text{kgf}$

 $1\text{kgf/cm}^2 \approx 0.098\text{MPa}$
 $1\text{kgf} \approx 9.8\text{N}$

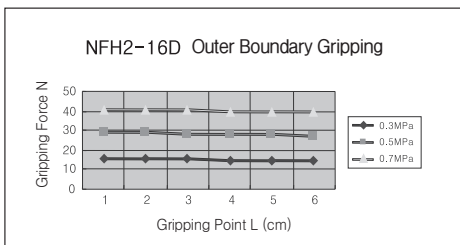

- ④ Machine selection for calculation 1
 ※ In case NFH2-16D is selected
 Gripping force 15.7N is achieved at the intersection of gripping distance L=2cm and pressure 0.3MPa.
 ※ Gripping force is 16 times of work weight, and it satisfies over 10 times of gripping set value.

Note : Apply loading under the range or application limit.
 It may cause deterioration of shaking, excessive unequal loading to guide part, negative effect to lifespan, etc, if applied over the range.

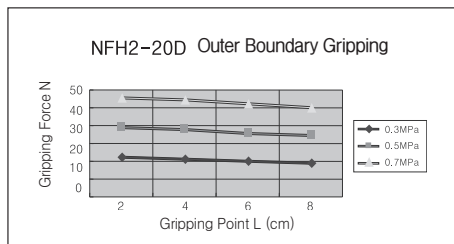

- ⑤ Machine selection for calculation 1
 ※ In case NFH2-20D is selected
 Gripping force 22N is achieved at the intersection of gripping distance L=2cm and pressure 0.3MPa.
 ※ Gripping force is 22 times of work weight, and it satisfies over 20 times of gripping set value.

4 Machine Selection Diagram

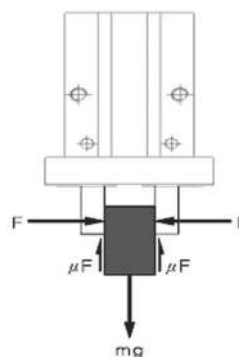

- ※ When work gripped as it is shown in the figure above,
 F : Gripping force(N)
 μ : Frictional coefficient between appendage and work
 m : Mass of work(kg)
 g : Gravitational acceleration(= 9.8m/s²)
 mg : Weight of work(N)

The condition which work is not dropped is,
 $F > mg / 2\mu$ along $2 * \mu F > mg$
 If F is determined with margin ratio a,
 $F = mga / (2\mu)$

Note) In case of high degree of acceleration or impact, bigger margin should be considered for calculation.

Series NF

Before to Apply Air Chuck

How to Attach of Air Chuck / NFH2 Series

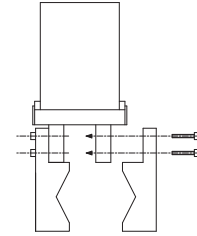
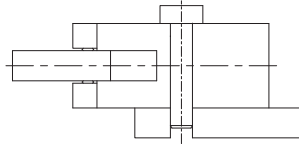
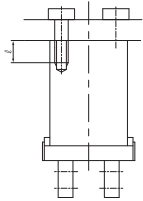

Machine Type	Bolt Applied	Maximum Connecting Torque N*m(kgf*cm)	Maximum Tightening Depth ℓ
NFH2-10D	M3×0.5	0.88(9)	6
NFH2-16D	M4×0.7	2.1(21)	8
NFH2-20D	M5×0.8	4.3(44)	10
NFH2-25D	M6×1	7.3(74)	12

Machine Type	Bolt Applied	Maximum Connecting Torque N*m(kgf*cm)
NFH2-10D	M3×0.5	0.49(5)
NFH2-16D	M4×0.7	0.88(9)
NFH2-20D	M5×0.8	2.1(21)
NFH2-25D	M6×1	4.3(44)

Machine Type	Bolt Applied	Maximum Connecting Torque N*m(kgf*cm)
NFH2-10D	M2.5×0.45	0.31(3.2)
NFH2-16D	M3×0.5	0.59(6)
NFH2-20D	M4×0.7	1.4(14)
NFH2-25D	M5×0.8	2.8(29)

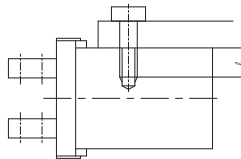
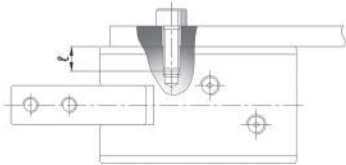

Machine Type	Bolt Applied	Maximum Connecting Torque N*m(kgf*cm)	Maximum Tightening Depth ℓ
NFH2-10D	M3×0.5	0.69(7)	5
NFH2-16D	M4×0.7	2.1(21)	8
NFH2-20D	M5×0.8	4.3(44)	10
NFH2-25D	M6×1	7.3(74)	12

Machine Type	Bolt Applied	Maximum Connecting Torque N*m(kgf*cm)	Maximum Tightening Depth ℓ
NFH2-10D	M3×0.5	0.9(9)	6
NFH2-16D	M4×0.7	1.6(16)	6.5
NFH2-20D	M5×0.8	3.3(34)	8
NFH2-25D	M6×1	5.9(60)	10

How to Attach of Air Chuck / NFW2 Series

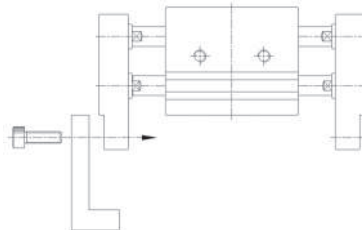
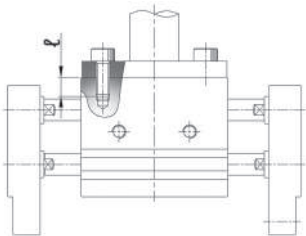

Machine Type	Bolt Applied	Maximum Connecting Torque N*m(kgf*cm)	Maximum Tightening Depth ℓ
NFW2-10A(B)	M4×0.7	1.6(16)	5
NFW2-12A(B)	M4×0.7	1.6(16)	6
NFW2-16A(B)	M5×0.8	3.3(34)	6
NFW2-20A(B)	M6×1	5.9(60)	7
NFW2-25A(B)	M6×1	5.9(60)	7
NFW2-30A(B)	M8×1.25	18(183)	8

Machine Type	Bolt Applied	Maximum Connecting Torque N*m(kgf*cm)
NFW2-10A(B)	M3×0.5	0.59(6)
NFW2-12A(B)	M4×0.7	1.4(14)
NFW2-16A(B)	M5×0.8	2.8(29)
NFW2-20A(B)	M6×1	5.9(60)
NFW2-25A(B)	M6×1	5.9(60)
NFW2-30A(B)	M8×1.25	18(183)

- SB
- NF**
- NR
- ASL
- LOW SPEED CYLINDER
- CHANGE OF ROD END SHAPE
- TPC-1000
TPC-1200
- SAH
- NBU
- ACU
- SE
- ARM

Series NF

How to Attach Method of Air Chuck / NFP2 Series

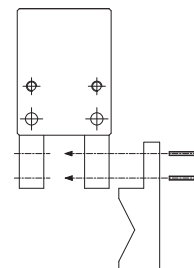
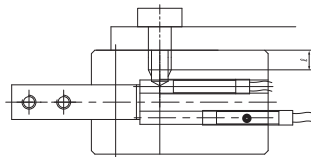
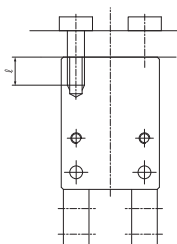

Machine Type	Bolt Applied	Maximum Connecting Torque N*m(kgf*cm)	Maximum Tightening Depth ℓ
NFP2-12D	M3×0.5	0.88(9)	5
NFP2-16D	M4×0.7	2.1(21)	8
NFP2-20D	M4×0.7	2.1(21)	10
NFP2-25D	M5×0.8	4.3(44)	12
NFP2-32D	M5×0.8	4.3(44)	12
NFP2-40D	M5×0.8	4.3(44)	12

Machine Type	Bolt Applied	Maximum Connecting Torque N*m(kgf*cm)	Maximum Tightening Depth ℓ
NFP2-12D	M4×0.7	2.1(21)	5
NFP2-16D	M4×0.7	2.1(21)	6
NFP2-20D	M5×0.8	4.3(44)	6
NFP2-25D	M5×0.8	4.3(44)	8
NFP2-32D	M5×0.8	4.3(44)	10
NFP2-40D	M6×1	7.3(76)	12

Machine Type	Bolt Applied	Maximum Connecting Torque N*m(kgf*cm)
NFP2-12D	M3×0.5	0.88(9)
NFP2-16D	M4×0.7	2.1(21)
NFP2-20D	M4×0.7	2.1(21)
NFP2-25D	M5×0.8	4.3(44)
NFP2-32D	M5×0.8	4.3(44)
NFP2-40D	M6×1	7.3(76)

Series NF

Machine Selection

Effective Gripping Force Checking

- A Method Showing Effective Gripping Force

Effective gripping force in the graph below is shown as 1 finger thrust F under the condition which 2 fingers and appendage are all connected to the work.

NFH2/Standard

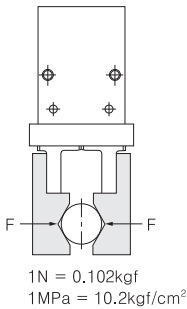

Inner Boundary Gripping Condition

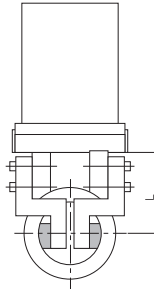

Outer Boundary Gripping Condition NFH2/Standard

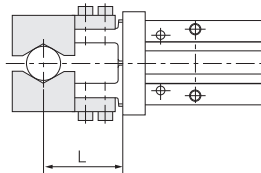

Machine Selection Basis For Work Mass

- Although frictional coefficient between appendage and work is different along the shape, please select machine type which allows more than 10~20 times bigger gripping force than work weight.
- There should be bigger margin considered for high degree of acceleration or impact when returning the work.

SB

NF

NR

ASL

LOW SPEED CYLINDER

CHANGE OF ROD END SHAPE

TPC-1000 TPC-1200

SAH

NBU

ACU

SE

ARM

NFH2 Gripping Force Graph (Effective Gripping Force)

Outer Boundary Gripping Condition

Inner Boundary Gripping Condition

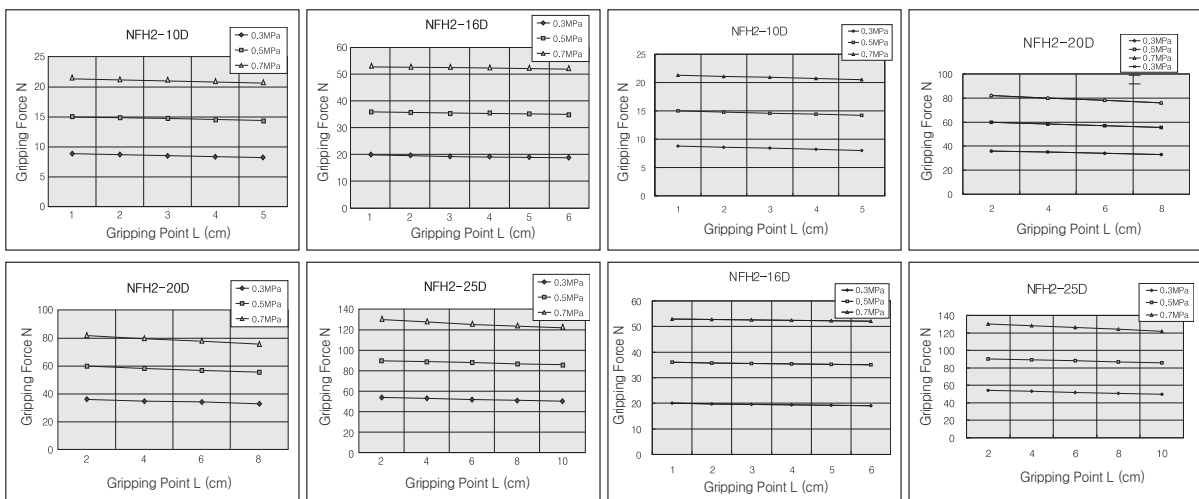

Series NF

Machine Selection

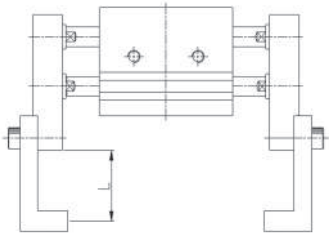

Machine Selection Basis For Work Mass

- Although frictional coefficient between appendage and work is different along the shape, please select machine type which allows more than 10~20 times bigger gripping force than work weight.
- Moreover, there should be bigger margin considered for high degree of acceleration or impact when returning the work.

NFW2 Gripping Force Graph (Theoretical Gripping Force)

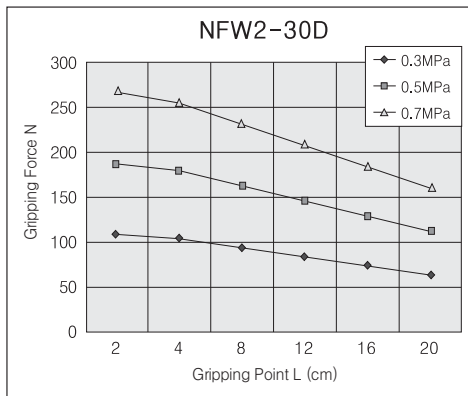
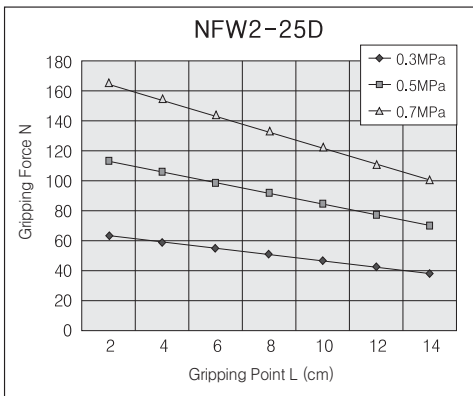
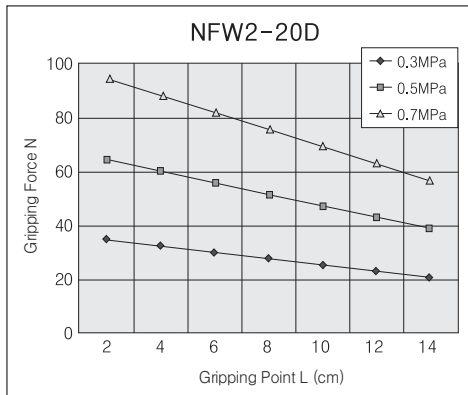
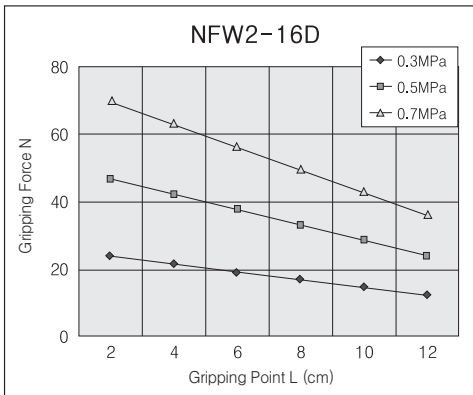
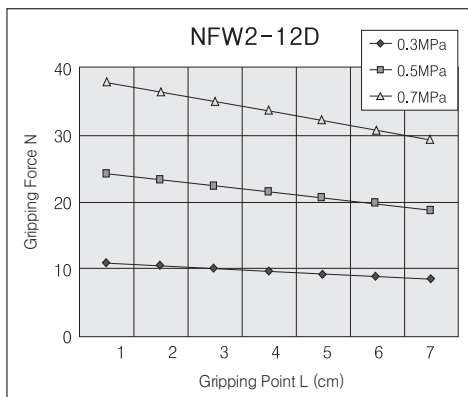
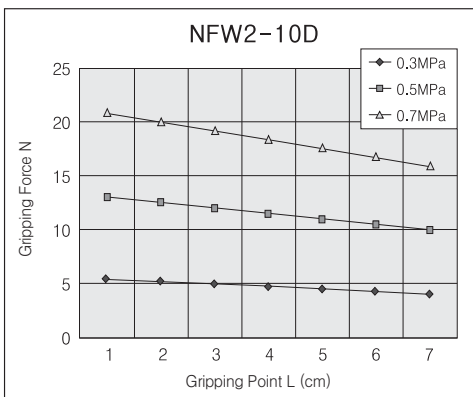

Series NF

Machine Selection

Gripping Point

- Please apply gripping point of work within the range of theoretical gripping force graph.

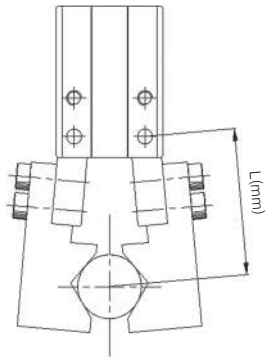

Machine Selection Basis For Work Mass

- Although frictional coefficient between appendage and work is different along the shape, please select machine type which allows more than 10~20 times bigger gripping force than work weight.
- Moreover, there should be bigger margin considered for high degree of acceleration or impact when returning the work.

- Indicating method of theoretical gripping force

Theoretical gripping force in the graph below is shown as 1 finger thrust F under the condition which 2 fingers and appendage are all connected to the work.

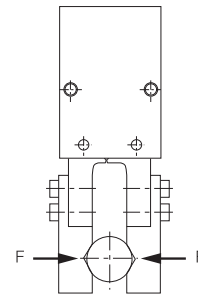

NFP2 Gripping Force Graph (Theoretical Gripping Force)

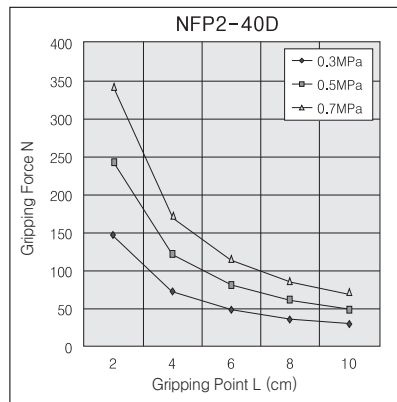
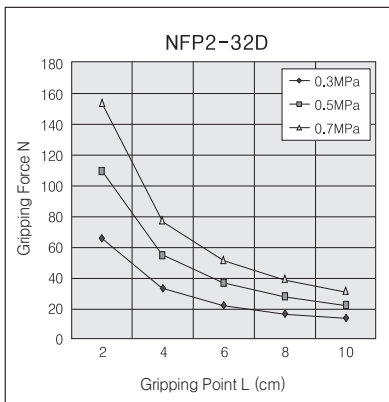
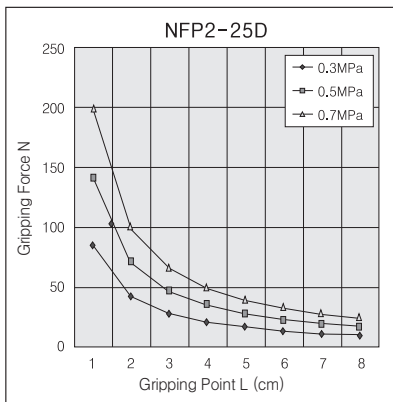
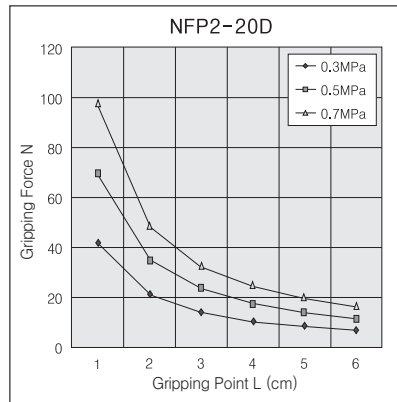
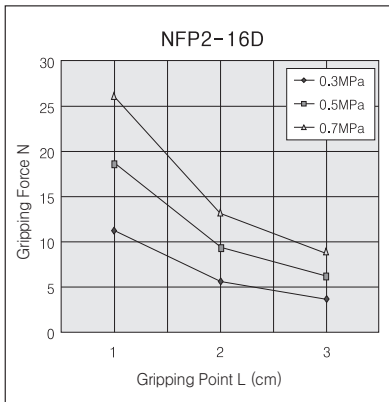
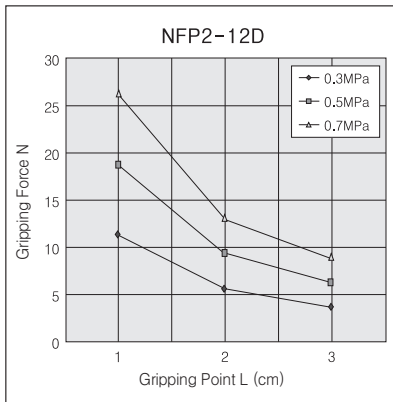

SB
NF
NR
ASL
LOW SPEED CYLINDER
CHANGE OF ROD END SHAPE
TPC-1000 TPC-1200
SAH
NBU
ACU
SE
ARM

Series NF

Actual Gripping Force

Gripping Point

- Please apply gripping point of work within the range of theoretical gripping force graph.

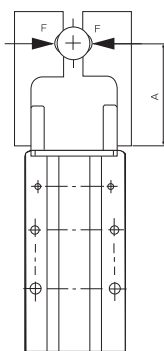

Machine Selection Basis For Work Mass

- Although frictional coefficient between appendage and work is different along the shape, please select machine type which allows more than 10~20 times bigger gripping force than work weight.
- Moreover, there should be bigger margin considered for high degree of acceleration or impact when returning the work.

- Indicating method of theoretical gripping force

Theoretical gripping force in the graph below is shown as 1 finger thrust F under the condition which 2 fingers and appendage are all connected to the work.

Gripping Force Graph(Theoretical Gripping Force)

